

SMD Switch

SI-C3432A-5517

Features

- External Dimensions : 3.4mm x 3.2mm, Height 0.55mm
- Suitable for thinner and lighter portable devices
- Suitable for water proof devices
- Reflow soldering
- Package With 12mm Wide Reel tape

Applications

- Applicable for Various devices such as mobile, phone, MP3, Camera, Audio, Video and Communication devices
- Low profile and Lightweight design

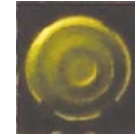

General specification

- Operating temperature: $-30^{\circ}\text{C} \sim +85^{\circ}\text{C}$, 45~85%RH
- Storage temperature: $-30^{\circ}\text{C} \sim +85^{\circ}\text{C}$, 45~85%RH
- Switch Type: Surface mount
- Operating direction: Vertical
- Minimum packing unit(pcs): 7,000pcs
- Electrical characteristics
 - Insulation resistance: 100m Ω min. 100V DC
 - Contact resistance: 250V AC , 1minute
 - Rating: 50mA 12V DC
- Environmental specification
 - Resistance to low temperature: $-30 \pm 2^{\circ}\text{C}$, 96hr
 - Heat resistance: $80 \pm 2^{\circ}\text{C}$, 96hr

Soldering conditions

- Reflow Soldering condition

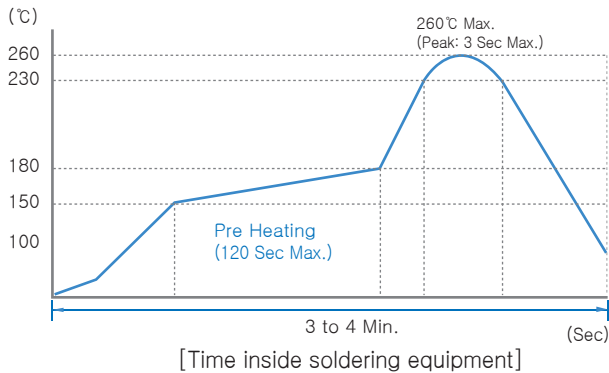

- Manual condition

Item	Condition
Soldering temperature	350 °C max
Duration of soldering	3 sec max.
Capacity of soldering iron	60W max.

Packing specification

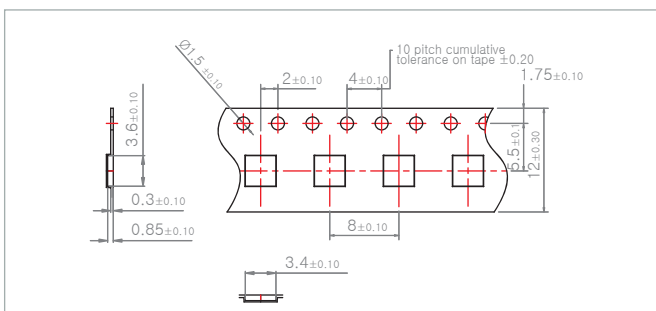

Part number	SI-C3432A-5517	
Type	Surface mount	
Operating force	170gf ± 50	
Operating direction	Vertical	
Travel	0.15 ± 0.1mm	
Operating life (50mA 12V DC)	200,000 cycles	
Initial contact resistance	200 m Ω max.	
Minimum order unit (pcs.)	7,000pcs / Reel	
Series type	Sharp feeling type	
Operating temperature range	-30°C to $+85^{\circ}\text{C}$	
Rating (max.)	50mA 12V DC	
Rating (min.)	10 μA 1V DC	
Electrical performance	Insulation resistance	100 m Ω min. 100V DC
	Contact resistance	250V AC for 1 minute
Durability	Vibration	10 to 55 to 10Hz/min., the amplitude is 1.5mm for all the frequencies, in the direction of X, Y and Z for 2 hours respectively
	Environmental performance	Cold: $-30^{\circ}\text{C} \pm 2^{\circ}\text{C}$ for 96h Dry heat: $80^{\circ}\text{C} \pm 2^{\circ}\text{C}$ for 96h Damp heat: $60^{\circ}\text{C} \pm 2^{\circ}\text{C}$, 90 to 95%rhRH for 96h

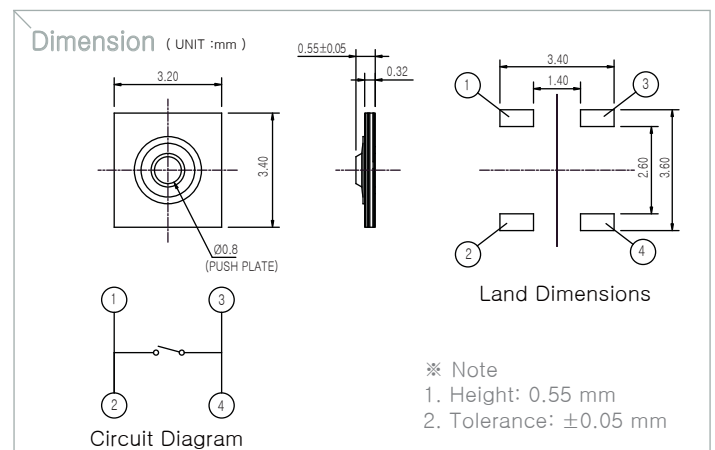

Standard Reel Dimensions (mm)

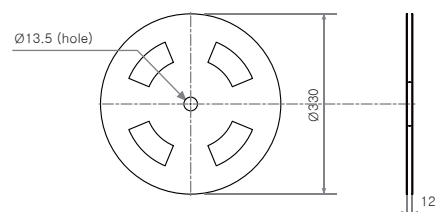

Packing unit: 7,000pcs/Reel

※ Operation feeling shall be measured after 20times pre-operations for Dome s/w center.



TO : _____

Issue No : 2012. 07. 02

Issue Date : 2012. 07. 02

[SPECIFICATION]
(APPROVAL SHEET)

Model Name : SI-C3432A-5517

Division		Drawing up	Checked	Approved
Customer	Signature			
	Date	/	/	/
Supplier	Signature			
	Date	7 / 2	7 / 2	7 / 2

1. General Specification:

- 1-1. Operating temperature rang: -30°C ~ +85°C
- 1-2. Storage temperature rang: -30°C ~ +80°C
- 1-3. Rating: 50mA 12V DC(Max.)

2. Appearance, style and dimensions

- Appearance : There shall be no defects that affect the serviceability of the product.
- Style and dimensions : Refer to the assemble drawings.

3. Style of actuating : Tactile feedback

4. Contact arrangement : 1 pole 1 throw

5. Electrical characteristics

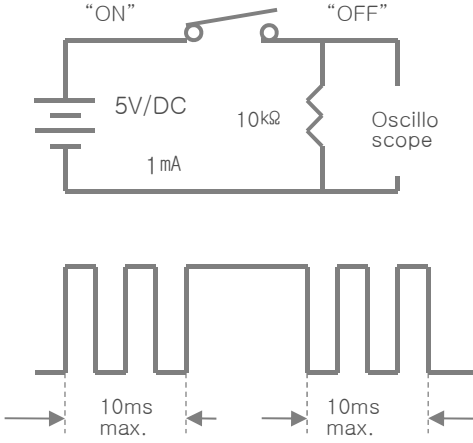
Items	Test conditions	Criteria
1) Contact resistance	-.Push force: Operation force ×2 -.Test Method: Capable of 10μA~10mA with Contact resistance meter	500mΩ Max.
2) Withstand voltage	-.Test Method:250V/AC(50Hz~60Hz) for 1minute between terminals or frame	There shall be no breakdown
3) Insulation resistance	-.Test Method :100V/DC(50Hz~60Hz) between terminals or frame	100MΩ Min.
4) Bounce	-. Lightly striking the center of the stem at a rate encountered in normal use (3 ~ 4 times /sec) , bounce shall be tested at "On" and Off" 	"ON bounce: 10msec Max. "OFF bounce: 10msec Max.

6. Mechanical characteristics

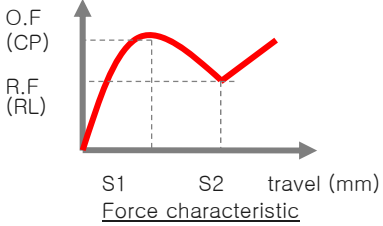
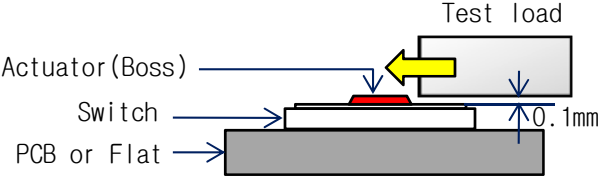
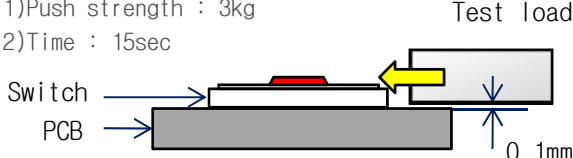
<p>1) Operation force</p>	<p>-. Measured operation force at stop point when pushed dome s/w center.</p>  <p style="text-align: center;"><u>Force characteristic</u></p>	<p>170 ± 50gf</p>
<p>2) Travel to closure</p>	<p>Measured distance from switch top to stop point when pushed switch center.</p>	<p>0.15 ± 0.1mm</p>
<p>3) Return force</p>	<p>The sample is installed such that the direction of switch operation is vertical and upon depression of the stem in its center the whole travel distance, the force of the stem to return tot its free position shall be measured. Refer to fig < 1) item></p>	<p>30gf Min.</p>
<p>4) Life cycles</p>	<p>1) Operating speed : 2~3 times/s 2) Force : 500kgf 3) Duration : 200,000 times</p>	<p>6 Item shall be satisfied and mechanical value within ±50% before testing</p>
<p>5) Strength adhesive actuator</p>	 <p>-. Tested strength adhesive actuator as the fig</p> <p>1) Test load : 3 N 2) Time : 15 sec</p>	<p>No fall apart and no separate.</p>
<p>6) Side push strength (soldering strength)</p>	<p>-. After reflow process</p> <p>1) Push strength : 3kg 2) Time : 15sec</p> 	<p>No damage (electrical and mechanical)</p>
<p>7) Stop strength</p>	<p>Placing the switch such that direction of switch operation is vertical and then a below static load shall be applied in the direction of stem operation.</p> <p>(1) Depression : 3kgf (2) Time : 15 sec</p>	<p>There shall be no sine of damage mechanically and electrically</p>

7. Environmental specification

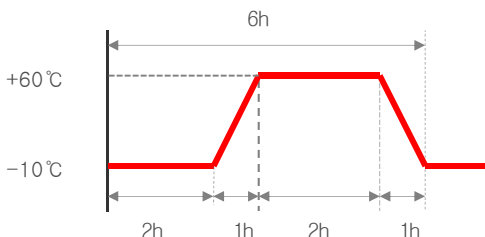
1) Resistance to low temperature	1)Temperature : $-30^{\circ}\text{C} \pm 2^{\circ}\text{C}$ 2)Time : 96h 3)Water drops shall be removed and made normal conditions for 1hour before measurement.	Contact resistance: 1000m Ω Max. 5 Item to 6 Item shall be satisfied
2) Heat resistance	1)Temperature : $+80^{\circ}\text{C} \pm 2^{\circ}\text{C}$ 2)Time : 96h 3)Made normal conditions for 1hour before measurement.	Contact resistance: 1000m Ω Max. 5 Item to 6 Item shall be satisfied
3) Change of Temperature	1)Test cycles : 5cycles as below 2)Water drops shall be removed and made normal conditions for 1hour before measurement 	Contact resistance: 1000m Ω Max. 5 Item to 6 Item shall be satisfied
4) Humidity test	1)Temperature : $60^{\circ}\text{C} \pm 2^{\circ}\text{C}$ 2)Relative humidity : 90%~95% 3)Time : 96h 4)Water drops shall be removed and made normal conditions for 1hour before measurement.	Contact resistance: 1000m Ω Max. 5 Item to 6 Item shall be satisfied
5) Salt spray test	1)Temperature : $35^{\circ}\text{C} \pm 2^{\circ}\text{C}$ 2)Solution : $5 \pm 1\%$, NaCl 3)Time : $48 \pm 1\text{h}$ 4)Water drops shall be removed and made normal conditions for 1hour before measurement.	Contact resistance: 1000m Ω Max. 5 Item to 6 Item shall be satisfied
6) Soldering Heat test	Mount the switch on P.W.B or P.C.B by adhesive. 1)Reflow process 2 times (Refer to reflow process conditions) Standard conditions after test : 1h	Contact resistance: 1000m Ω Max. 5 Item to 6 Item shall be satisfied
7) Water proof	1)Solution : METHYL ORANGE 2)Time : 48h 3)Water drops shall be removed.	No infiltrate water into inside switch

■ Soldering conditions

1. Manual condition

1-1. Temperature and Time: 350°C Max and 3 Sec Max.

1-2. Capacity of soldering iron: 60W

2. Reflow soldering

1-1. Preheating time: 60s max.

1-2. Temperature: 260°C max.

1-3. Dipping time: 3s max.

1-4. Soldering time: 2 times max.

1-5. The thickness of cream solder : 0.15~ 0.2mm

■ Reflow soldering condition

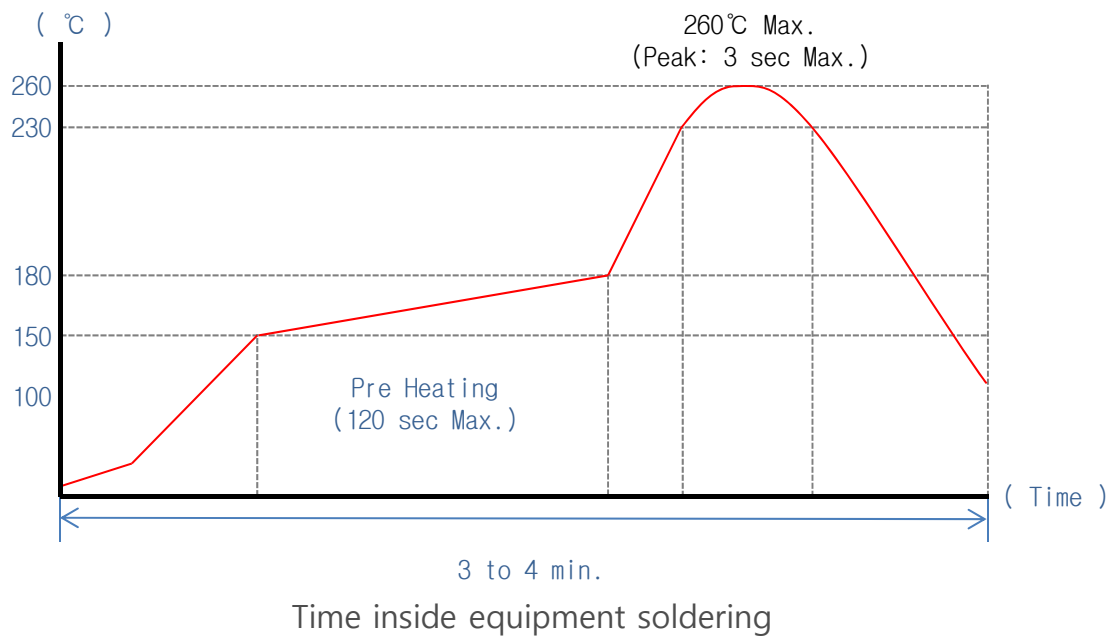

■ Packaging

1. Refer to attached a drawing
2. Packing unit : 7,000pcs/REEL

■ Precaution in use

1. General :

- 1) This product has been designed and manufactured for general electronic devices, such as audio, video, mobile phone, camera and etc.
- 2) This product is designed and manufactured assuming that it is to be use with the resistance for direct current. if you use other kinds of resistance or capacitive, please let us know beforehand.

2. Soldering and assemble to PC board process

- 1) Note that if the load is applied to the terminals during soldering They might suffer deformation and defects in electrical performance.
- 2) Conditions of soldering shall be confirmed under actual production conditions.
- 3) Avoid consecutive of soldering. If consecutive of soldering or heating, click rate may deteriorate, so please performed in the shortest period and the lowest temperature possible.
- 4) Please let us know, especially when you use any other method of soldering except recommended one.
- 5) Please refer to manual condition when you re-soldering

3. Washing process

- 1) Do not try to clean the switch with a solvent or the like.

4. Mechanism design

- 1) The dimensions of a hole and pattern for mounting a printed circuit board shall refer to the recommended dimensions in the engineering drawings.

5. Measurement Conditions

1) Operation force, Click Test Conditions

- Operation feeling shall be measured after 20times pre-operations for dome s/w center.
- It is recommended that tip of the keying section is flat.
- Allowable inclination of keying section : 90 ± 3 degrees or les.

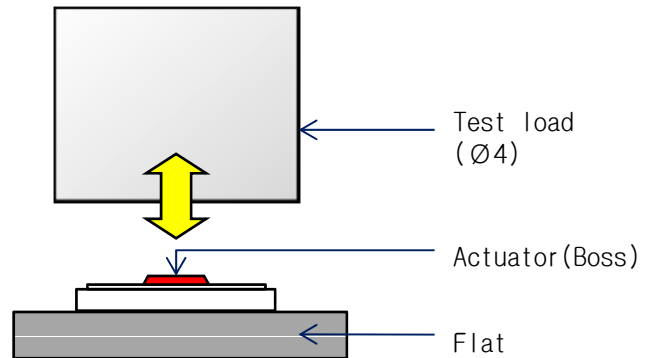

2) Life Test Conditions

- Operating speed : 2times/s
- Push force : 500gf
- Duration : 200,000 times
- About 0.3~0.5mm after leaving space, operates from the condition where the switch has become the junction.

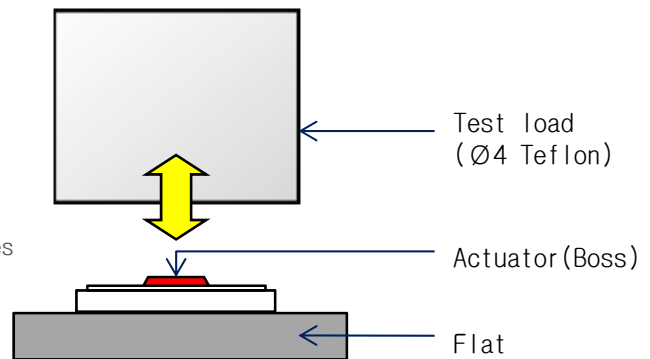

6. Others

- 1) If the switch is given stress from the side, it may result in damages to switch functions. therefore please handle it with extreme care. when the switch is carried, any shock shall not be applied to the switch.
- 2) Do not push except the actuating area.
- 3) Do not use the product in a manner that the switch is kept being pressed.

SI-3432

NO	PART NAME	CODE NO.	SPEC	MATERIAL	QTY	REMARK

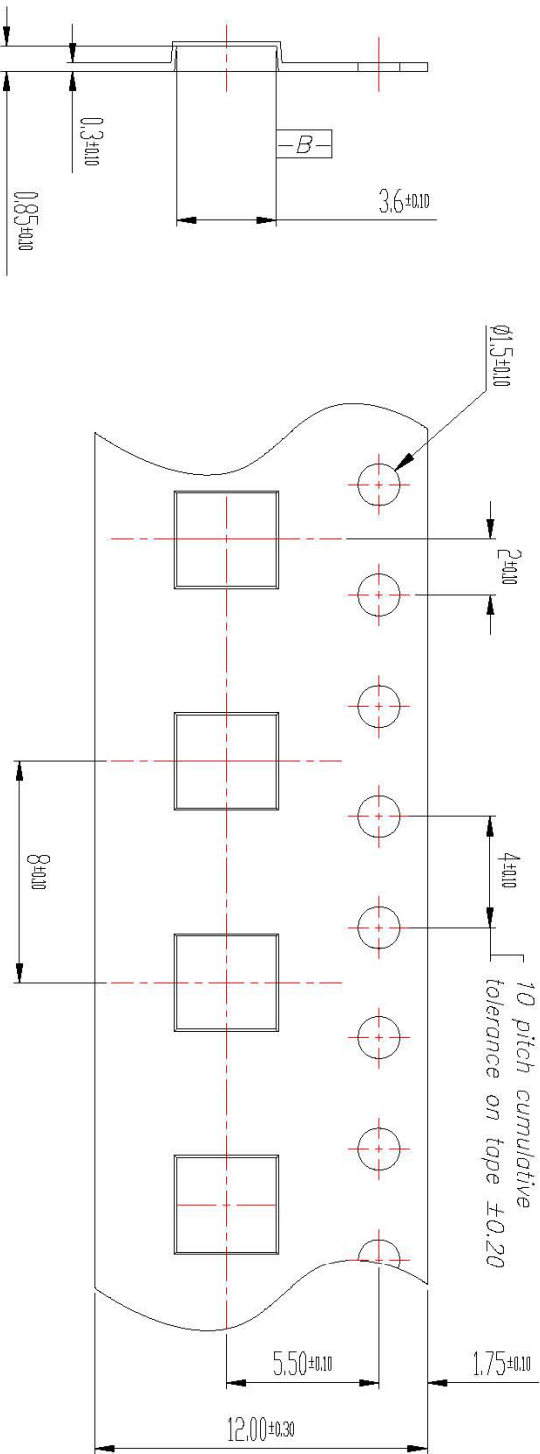

- NOTES: (UNLESS OTHERWISE SPECIFIED)
1. 10 SPROCKET HOLE PITCH CUMULATIVE TOL. ± 0.2
 2. CAMBER NOT TO EXCEED 1mm IN 100mm.
 3. MATERIAL : CLEAN NON- CONDUCTIVE POLYSTYRENE.
 4. K_0 MEASURED FROM A PLANE ON THE INSIDE BOTTOM OF THE POKKET TO THE TOP SURFACE OF THE CARRIER.
 5. POKKET POSITION RELATIVE TO SPROCKET HOLE MEASURED AS TRUE POSITION OF POKKET, NOT POKKET HOLE.
 6. ALL DIMENSIONS ARE IN MILLIMETERS.

Standard Tolerance

Range	Grade 1	Grade 2
0~4	± 0.05	± 0.1
4~10	± 0.08	± 0.15

PRODUCT NAME	CARRIER	UNIT	mm	DESIGN	CHECK	APPROVAL
MODEL NAME	SI-3432	SCALE	1 : 1	H. HEO	KHLEE	G.J. KIM
DRAWING No.		TOLERANCE	GRADE 1	2011.01.12	2011.01.12	2011.01.12

SIT SAMIL TECHNOLOGY Co., Ltd.

NO	REVISION RECORD	DATE	DR	CK
1				
2				
3				

NO	5	6	7	8
1				
2				
3				

SI-C3432A

NO	PART NAME	CODE NO.	SPEC	MATERIAL	QTY	REMARK
----	-----------	----------	------	----------	-----	--------

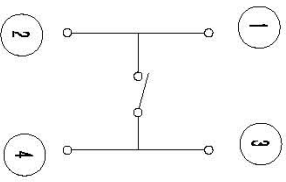
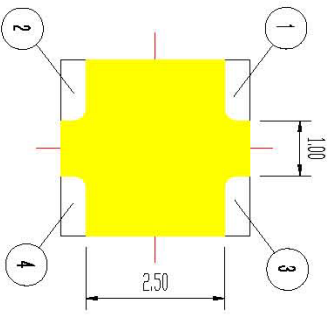
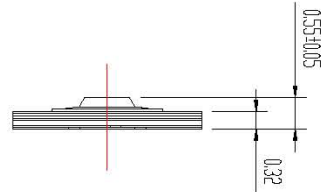
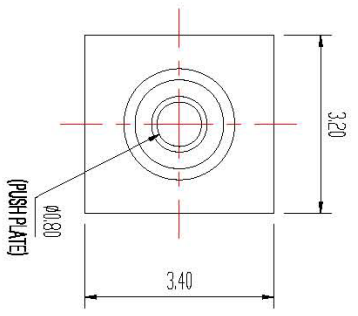

CIRCUIT DIAGRAM

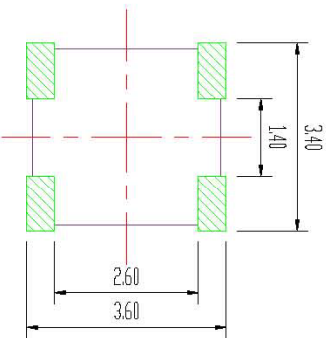
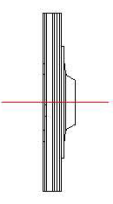

PCB LAND DIMENTION

SPECIFICATION

1. RATING : 50mA DC12V Max.
2. OPERATING FORCE : 170±50gf
3. CONTACT RESISTANCE : 100mΩ Max.
4. TRAVEL : 0.15±0.1mm
5. LIFE : 200,000cycles Min.

Standard Tolerance

Range	Grade 1	Grade 2
0~4	±0.05	±0.1
4~10	±0.08	±0.15

PRODUCT NAME	SMD SWITCH	UNIT	mm	DESIGN	H. HEO	CHECK	K.H.LEE	APPROVAL	G.J.KIM
MODEL NAME	SI-C3432A-5517	SCALE	1 : 1	DESIGN	2011.01.12	CHECK	2011.01.12	APPROVAL	2011.01.12
DRAWING No.		TOLERANCE	GRADE 1						

SIT SAMIL TECHNOLOGY Co., Ltd.

CODE NO

NO	REVISION RECORD	DATE	DR	OK
1				
2				
3				

5	6	7	8
---	---	---	---

5	6	7	8
---	---	---	---